

Drawer Frame Assembly and Installation Guide

Please read all of the instructions before beginning assembly and installation.

Basic Tools For elfa[®] Assembly and Installation

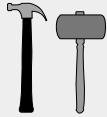

Hammer or
Plastic Mallet



Wood block to pro-
tect the floor

Easy to Install



Use Frame Sides with the same height and the same depth.



Face the Runners towards each other.



Assemble with Crossbars.



Combine Frame Sides for a variety of heights.

Drawer Frame Unit Components

An elfa[®] Drawer Frame Unit consists of the Frame and the Drawers that slide into the Frame. The Frame is made up of two Frame Sides and a set of four Crossbars.

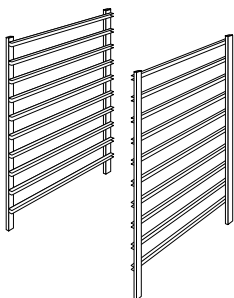

Frame Sides

+

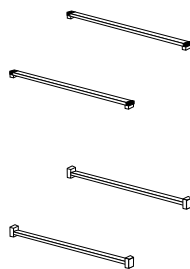

Crossbars
Basic Set

=

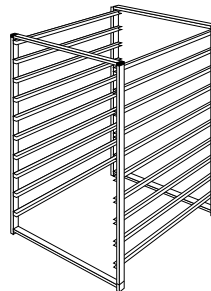

Frame

+

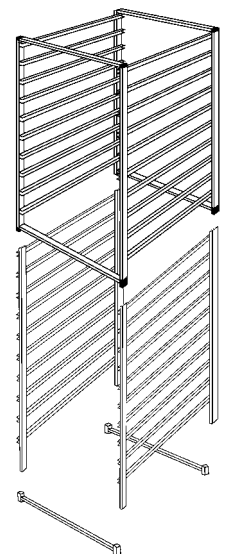

Crossbars
Extra Bottom Set

elfa® Drawer Frame Assembly

Please read all of the instructions before beginning assembly and installation.

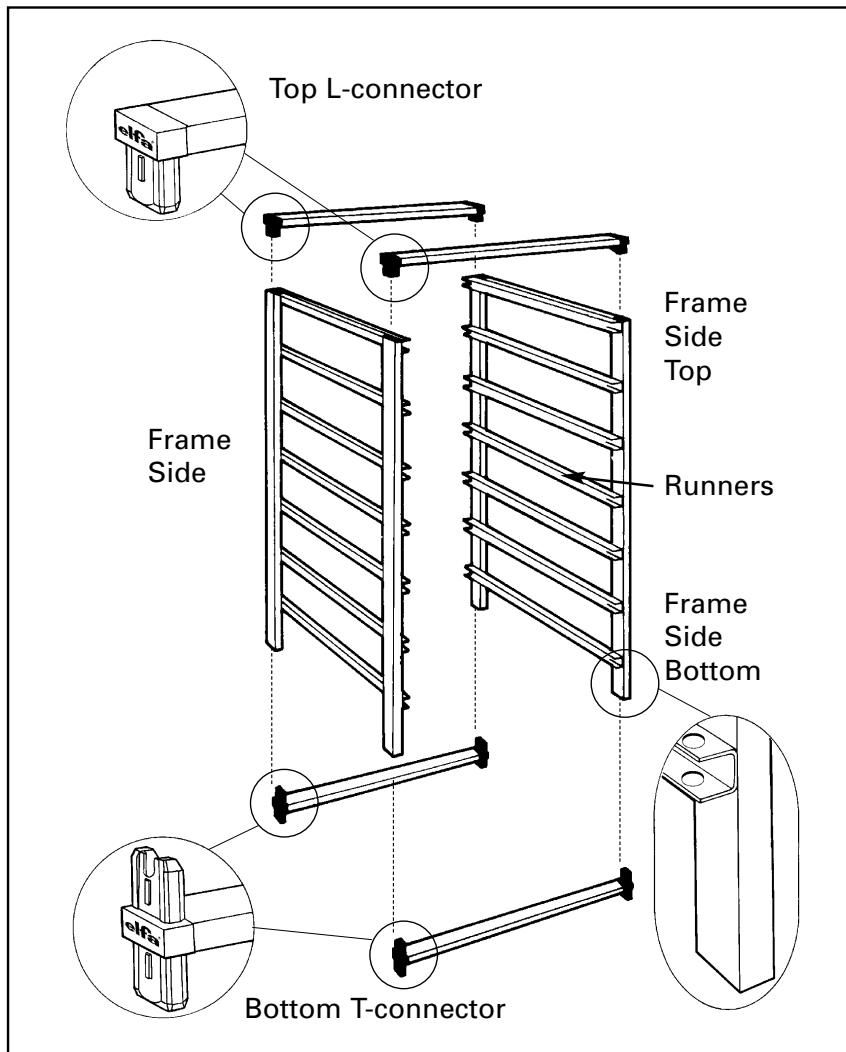

Use a plastic mallet or a metal hammer with a wood block to cushion the blow.

- 1. Tap the Bottom T-connectors into the bottom of each Frame Side. (Note: Runners should face inward.)**
- 2. Tap the Top L-connectors into the top of each Frame Side.**
- 3. Slide in the Drawers.**



Use a wood block to protect the floor during assembly.



You can add Frame Feet to protect the floor.

elfa® Drawer Frame Assembly

Please read all of the instructions before beginning assembly and installation.

elfa® Drawer Frames can be Combined for a Variety of Heights

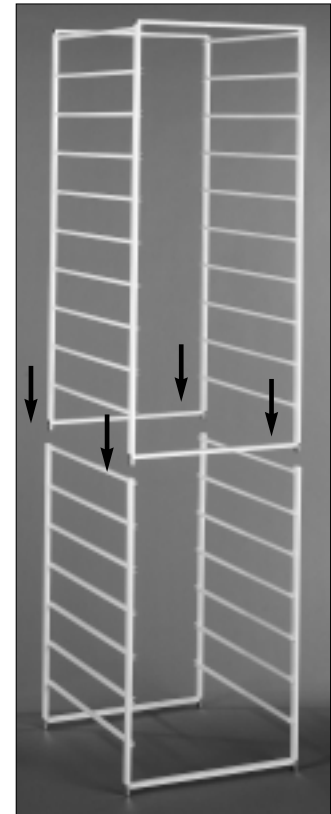
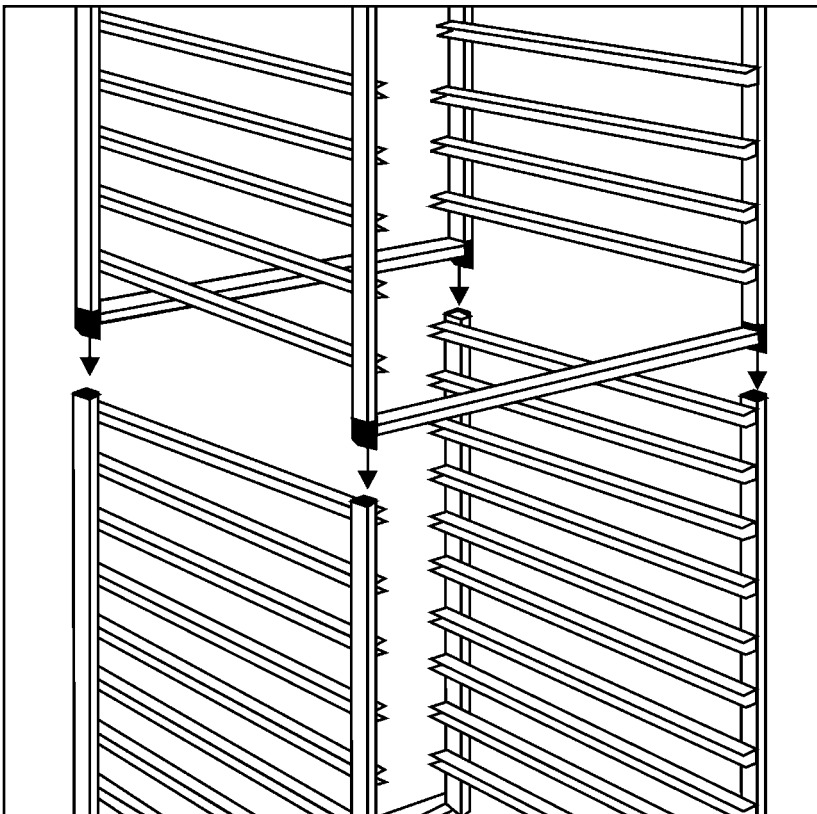

Use Frames Sides of the same width.

- 1. Assemble Top Frame Sides completely, as shown in page 2.**
- 2. Assemble Bottom Frame Sides omitting Top L-connectors**
- 3. Lower Top Frame Sides onto Bottom Frame Sides and secure by tapping each corner of the Top Frame Sides until it is completely locked into the Bottom Frame Sides.**



Use a wood block to protect the floor during assembly.



You can add Frame Feet to protect the floor.

Detailed installation guidelines follow the products.